



Stern Pod range Product data sheet - Pod 45



Details:	12V
Product ref.:	MPSPC312 / POD
Typical boat size:	20 - 34'
Tunnel diameter (inside):	125mm
Tunnel thickness:	4 - 5mm
Nominal power voltage:	12V
Control system voltage:	12V
Weight:	21kg

Performance data:

Test power voltage:	10.75V
Amperage:	300 Amps
kW	3.23
Hp:	4.3
Thrust kg / lbs:	40 / 88
Duty Cycle (S2):	3min

The POD 45 is part of Max Power's new Stern Pod range designed to simplify the traditionally problematic installation of stern thrusters in motor boats.

This single pre-assembled unit reduces potential installation errors, has twin propellers, a 125mm diameter stern tunnel complete with deflectors and a thrust rating of 40 / 88 (kg / lbs).

Unique Features:



Ignition Protected
& Water Resistant



Composite
drive legs
Zero
maintenance



Line
shields



High spec.
DC contactors



High power
connections



Purpose built
DC motors



Unrivalled
safety
features



Case hardened
spiro-conical gears

Stern Pod Installation:

Easy to install and requiring nothing other than simple electrical connections, the Stern Pod greatly reduces installation time.

The Stern Pod can be directly fitted from the outside of the boat thus requiring little or no work in the often inaccessible and cramped transom area.

Ignition protected and water resistant, the thruster's motor is protected from water and the corrosive atmosphere in the bilge.

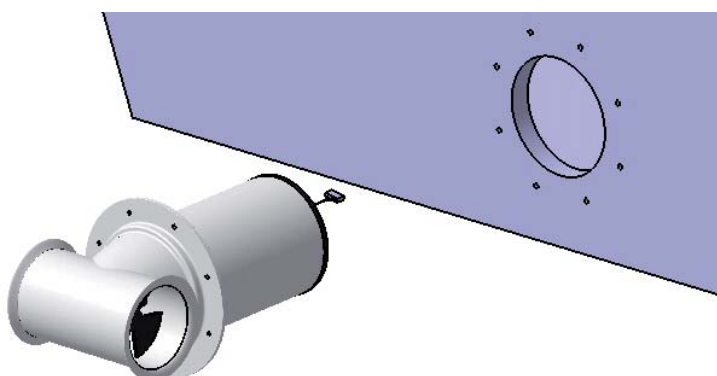

NB. Performance data is given for a thruster installed at one tunnel diameter immersion depth, in a tunnel no longer than twice the tunnel's diameter and this within a variation of + / - 6%. Higher voltages will result in higher thrust ratings, higher power consumption and a reduced duty cycle. Longer tunnels will result in lower thrust ratings and higher power consumption.